

# HLC1395

## Reflective Sensor

### FEATURES

- Side-looking plastic package
- Phototransistor output
- IR emitter and phototransistor detector in a single package
- Low profile for design flexibility
- Designed for short distance detection
- High sensitivity
- Unfocused for sensing diffused surfaces

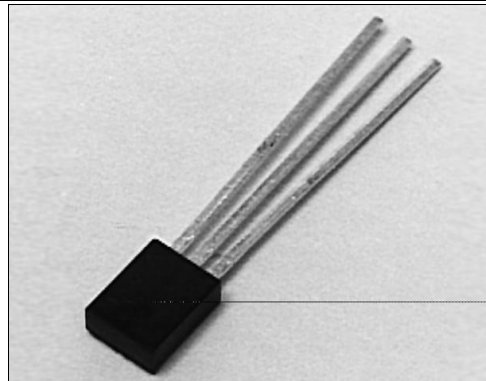

INFRA-58.TIF

### DESCRIPTION

The HLC1395 is a miniature infrared sensor designed to sense reflective objects at short distances. Both the GaAs IRED and the NPN phototransistor are mounted side-by-side in a single black plastic package with an integral barrier to minimize crosstalk. The sensor is configured with the IRED cathode and the phototransistor emitter connected to a common lead.



The housing consists of an opaque polysulfone outer shell with transfer-molded, IR-transmissive epoxy encapsulant. Housings are soluble in chlorinated hydrocarbons and ketones. Recommended cleaning agents are methanol and isopropanol.

### OUTLINE DIMENSIONS in inches (mm)

Tolerance 3 plc decimals  $\pm 0.010(0.25)$   
 2 plc decimals  $\pm 0.030(0.76)$

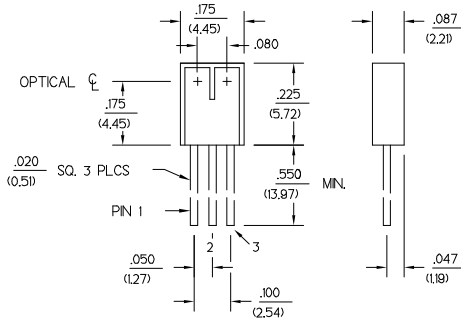

DIM\_029.cdr

# HLC1395

## Reflective Sensor

### ELECTRICAL CHARACTERISTICS (25°C unless otherwise noted)

PARAMETER	SYMBOL	MIN	TYP	MAX	UNITS	TEST CONDITIONS
<b>IR EMITTER</b>						
Forward Voltage	$V_F$		1.6		V	$I_F=20\text{ mA}$
Reverse Current	$I_R$		10		$\mu\text{A}$	$V_R=3\text{ V}$
<b>DETECTOR</b>						
Collector-Emitter Breakdown Voltage	$V_{(BR)CEO}$	30			V	$I_C=100\ \mu\text{A}$
Emitter-Collector Breakdown Voltage	$V_{(BR)ECO}$	5.0			V	$I_E=100\ \mu\text{A}$
Collector Dark Current	$I_{CEO}$		100		nA	$V_{CE}=10\text{ V}, I_F=0$
<b>COUPLED CHARACTERISTICS</b>						
On-State Collector Current	$I_{C(ON)}$				mA	$V_{CE}=5\text{ V}$
HLC1395-001		0.30				$I_F=10\text{ mA}$
HLC1395-002		0.60				(1)
Collector-Emitter Saturation Voltage	$V_{CE(SAT)}$		0.5		V	$I_C=40\ \mu\text{A}, I_F=10\text{ mA}$ (1)
Crosstalk (2)	$I_{CX}$		15		$\mu\text{A}$	$V_{CC}=5\text{ V}, I_F=10\text{ mA}$
Rise And Fall Time	$t_r, t_f$		15		$\mu\text{s}$	$V_{CC}=5\text{ V}, I_C=0.3\text{ mA}$ $R_L=1000\ \Omega$

#### Notes

- Test surface is Eastman Kodak neutral white test card with 90% diffuse reflectance located 0.040 in. (1.0 mm) from the front surface of the device.
- Crosstalk ( $I_{CX}$ ) is the collector current measured with current to emitter and no reflecting surface.

### ABSOLUTE MAXIMUM RATINGS

(25°C Free-Air Temperature unless otherwise noted)

Operating Temperature Range	-40°C to 85°C
Storage Temperature Range	-40°C to 85°C
Soldering Temperature (5 sec)	240°C

#### IR EMITTER

Reverse Voltage	3 V
Continuous Forward Current	50 mA
Power Dissipation	100 mW (1)

#### DETECTOR

Collector-Emitter Voltage	30 V
Emitter-Collector Voltage	5 V
Power Dissipation	100 mW (1)
Collector DC Current	30 mA

### SCHEMATIC

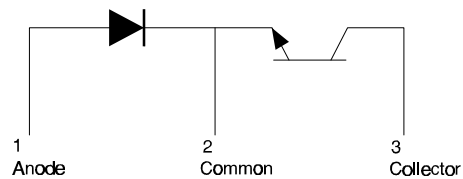

Honeywell reserves the right to make changes in order to improve design and supply the best products possible.

# Honeywell

# HLC1395

## Reflective Sensor

Fig. 1 Normalized Light Current ( $I_L$ ) vs Distance to Reflective Surface gra\_071.ds4

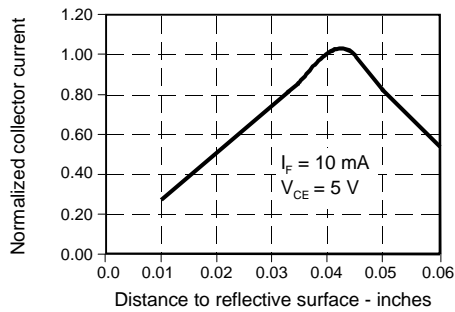

Fig. 2 Normalized Light Current ( $I_L$ ) vs IRED Forward Current gra\_072.ds4

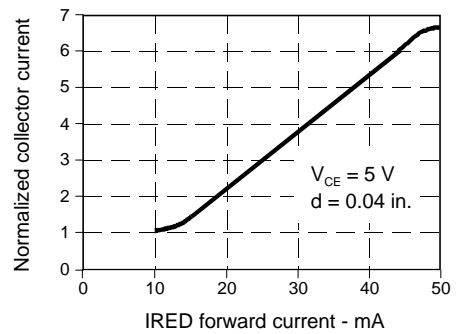

Fig. 3 IRED Forward Bias Characteristics gra\_073.ds4

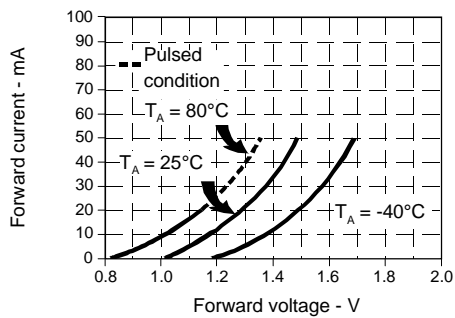

Fig. 4 Non-Saturated Switching Time vs Load Resistance gra\_074.ds4

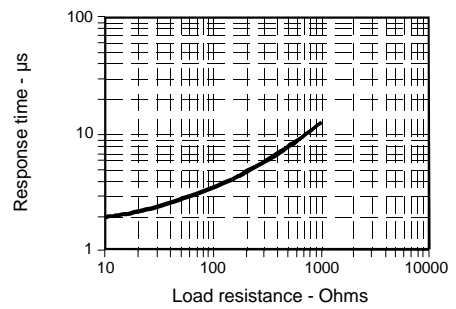

Fig. 5 Dark Current vs Temperature gra\_301.cdr

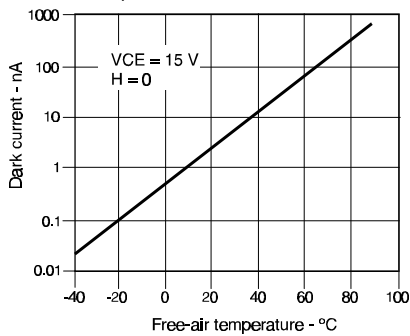
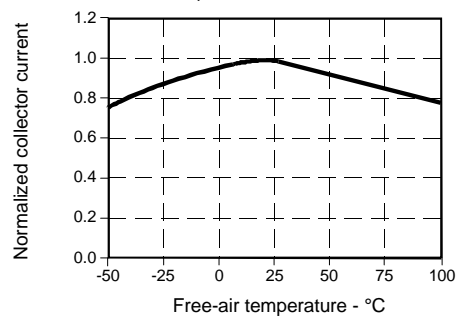

Fig. 6 Collector Current vs Ambient Temperature gra\_076.ds4



All Performance Curves Show Typical Values

**HLC1395**  
Reflective Sensor

---



Honeywell reserves the right to make changes in order to improve design and supply the best products possible.

**Honeywell**